

HYDROKOMP®

Hydraulische Komponenten GmbH

Technology that connects

Application Examples

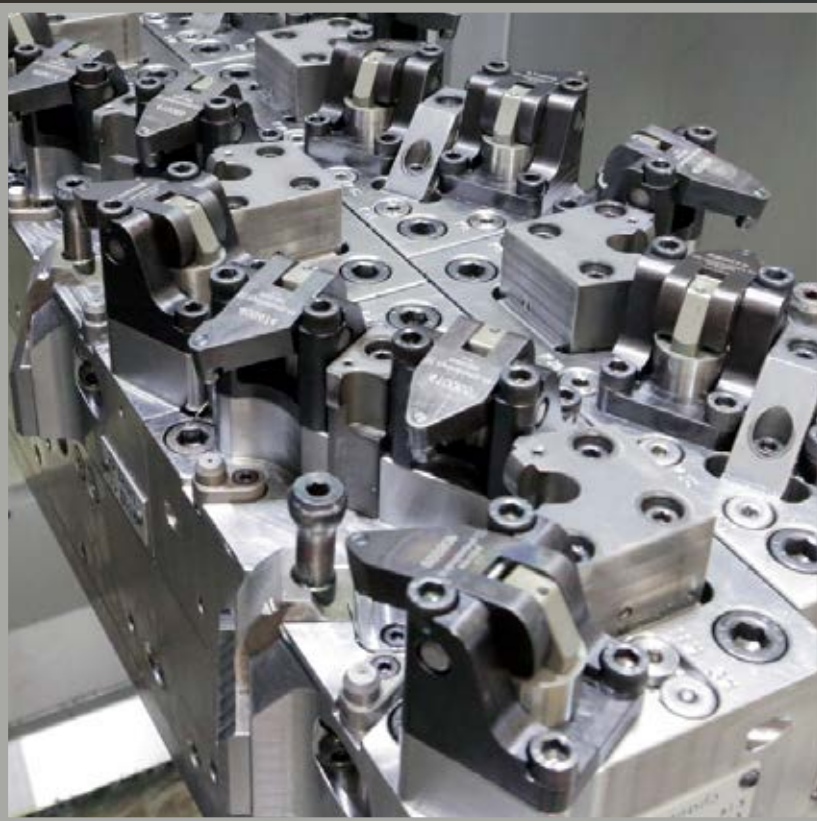

The application of hydraulic components

Ideas and quality are program

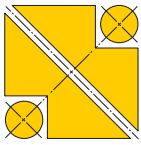

HYDROKOMP

Hydraulische Komponenten GmbH



HYDROKOMP Managing Directors

Foto: f.l.t.r. Dr. Friedrich Freund, Dipl.-Ing (FH) Karl-Heinz Freund and M.A. Felix Freund

Partner for mechanical engineering and fixture construction

Brand products and top service

Founded 1998, HYDROKOMP designs, manufactures and distributes hydraulic components, coupling systems and clamping technology for mechanical engineering, fixture construction, tooling and many other branches of industry also for different operating conditions.

Constructive ideas and customer-specific designs are our particular strengths. Our qualified employees and our modern CNC machinery ensure high flexibility product variety and quality according to DIN EN ISO 9001.



Consulting, development, manufacturing

Beginning with the consultation, over to product training and up to complete development of customer specific solutions, our applications engineers and design engineers are available to support and assist you.

Consistent accuracy

HYDROKOMP products are designed for longlasting application in rough industrial daily routine. Our customers can surely trust that the process will flow smoothly.

Each and every one of HYDROKOMP product is developed and manufactured according to the highest quality standards. With modern CAD systems we design new solutions. After that, current procedures of precision manufacture and quality assurance are next in process.

Before a product is released, it has to prove its quality with an endurance test. The result:
Ideas and quality right from the start.

Proven many times in practice

Hydraulic elements and coupling systems by HYDROKOMP are already in use very successfully in the most various industrial branches.

These are for example:

- ✘ Agricultural technology
- ✘ Machinery installations
- ✘ Resources
- ✘ Production engineering
- ✘ Molds and tools
- ✘ Handling technology
- ✘ Machinery
- ✘ Fixtures
- ✘ Packaging machinery
- ✘ Machine tools

References



Production



Administration



Save time and parts with integrated hydraulic couplings

Integrated media couplings open up the potential for more efficiency in machining centres. Among other things, they can replace some components, whose jobs they additionally take over.

Integrated media couplings contribute to more efficiency and economy. Thus they carry fluids and vacuum almost without losses, unlike simple hose and quick couplings. Furthermore modern media couplings in machining centres can take on additional functions: When setting up in the loading and unloading station they lock the coupling halves, for example, and allow turning movements in the desired work position. This is seen, for example, in the machining.

One method to increase the productivity in machining is to reduce the downtimes, especially the set up times. These can be reduced when the machine operator already prepares the workpieces parallel to the main time on a separate workpiece carrier and substitutes each one for machining.

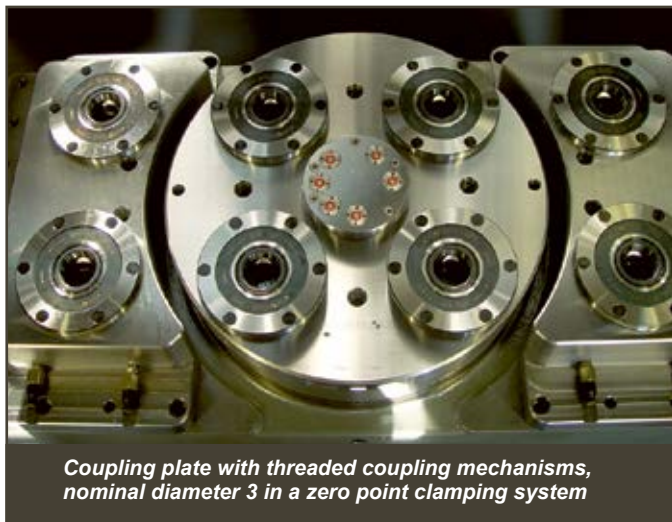

Coupling plate with threaded coupling mechanisms, nominal diameter 3 in a zero point clamping system

Then only the times for these changes occur. Now it must be determined whether the pallet is equipped with hydraulic or with mechanical clamping fixtures. In mechanical clamping fixtures the forces, with which the workpieces are clamped, can only be precisely controlled with special technology. The handling is complex and requires long downtimes. Especially in industrial series production this lengthens the cycle times and presents an impediment for the automation.

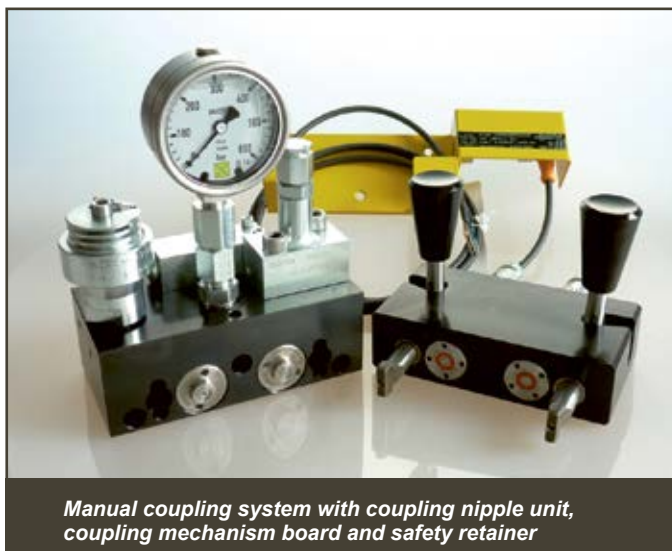

Manual coupling system with coupling nipple unit, coupling mechanism board and safety retainer

Here hydraulic clamping fixtures offer advantages, however the hydraulic oil of the fixture must remain under pressure during the change, and the work space of the machine must be connected with the pressure system of the fixture. If the machine is fed via conventional hydraulic lines/hoses with mechanical couplings, the change times are extended. In addition the unavoidable oil losses contaminate the machine and the environment. Integrated media couplings prevent these negative effects. HYDROKOMP offers standardised and individual components for manual or automated coupling; under pressure or not.

Selection of the coupling connections

The application gives the amount of the required clamping forces during the selection of the media coupling. The operating pressures of the hydraulic oil and the nominal width as measure for the size of the coupling elements are taken by the designer from the tables of the respective data sheet. A second, important criterion is the number of connections, which depends on the type of clamping functions on the work pieces and the valve technology. It is normal to accommodate each of the three translational and rotational degrees of freedom of a workpiece with a total of six fixed points.

The desired clamping sequence on the workpiece influences the selection of the valves and pressures. Thus it can be technically practical for pretensioning the workpiece to give a lower pressure and then after final positioning for fixing the workpiece to go to a higher value. The number of the coupling connections depends on the valve technology. If the valves are arranged on the workpiece carrier, two connections can be sufficient. If they are installed permanently between media coupling and pressure booster, two connections are required per valve circuit. However, since they are stationary outside of the work process, better design and access possibilities result. It relieves the workpiece carrier of weight and reduces the interference contours.



Coupling mechanisms and coupling nipples threaded variants and coupling mechanisms and coupling nipples built-in variants can be coupled without pressure

Additional information:

Subject	Data sheet	Webcode
⊗ Coupling elements	100-3	010003
⊗ Multiple coupling systems	100-4	010004
⊗ Mounting tools	100-5	010005
⊗ Automatic coupling mechanisms	100-6	010006
⊗ Rotary couplings	500-3	050003



Save time and parts with integrated hydraulic couplings

Additional functions replace components

When setting up in the loading and unloading station, the pallets or the workpiece carriers must be fixed. Normally clamping elements are required for this. This job can alternatively be done with a lock in the media coupling. The clamping elements are then omitted. Especially in the production of series production parts in machining centres it is usual for economic reasons to clamp as many workpieces as possible on one carrier. For this the fixture contains several vertical machining levels with horizontal tool spindles. For simpler setup, the workpiece carrier in the loading and unloading station can then be turned to the desired position. This movement including positioning can additionally take over a rotating bush of the media coupling.



4-fold coupling mechanism plate with (1) self-locking mechanism and (2) blow jets for cleaning the surface



The mounting tool that is equipped with a sealing ring makes the exchange of the sealing rings easier and faster

Automatic coupling mechanisms (AKM)

Coupling system for tools

In principle the media couplings for tools are like those for the workpiece carrier. They mainly transfer cooling lubricant or oil for control purposes. The interior channels of milling heads and tool carriers, such as revolver fixtures, feed the lubricant to the tool blade, for example. For these coupling jobs the automatic coupling mechanism systems (AKM systems) from HYDROKOMP are suitable: The coupling elements for liquid and gaseous media consist of rust resistant materials. They can be installed in the individual fixtures, for example, for multiple coupling systems. Depending on the sealing material, they are suitable for pressureless couplings or for coupling under pressure.

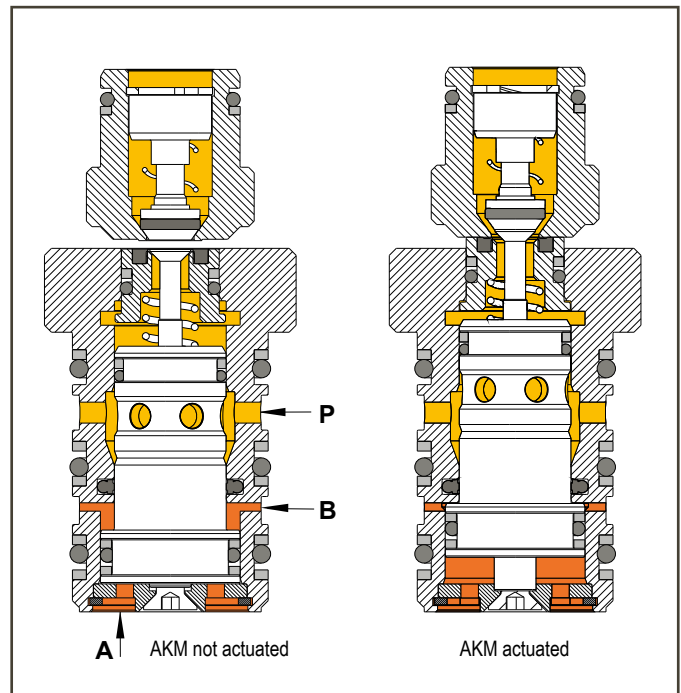

Functional schematic of the automatic coupling mechanism (AKM)

Left: Before establishing the connection

Right: State after connecting the coupling mechanism

Simplifying service

The system seals on the pistons of the coupling mechanism wear out after time due to contamination and shavings. As a rule the service personnel remove the coupling mechanism to change the seals in the coupling elements, replace the seal and reinstall the coupling mechanism. This can certainly last half of a working day.

Therefore for their coupling mechanisms HYDROKOMP designed and implemented a changing system that simplifies changing the system seals. In addition we have developed a special mounting tool, with which the service employee can replace a seal with a few hand movements in only a few minutes.



Automatic coupling mechanisms (AKM)

The patented AKM of the system combines the coupling parts or components without additional stroke. The hydraulically activated system spares, for example on rotary tables of tool machines, the otherwise necessary lifting equipment. Changing tables or pallets can be coupled with the rotary table by radial pushing alone.

For the AKM a gap is sufficient between the coupling elements. It allows the desired rotational movement in the decoupled state and can be from 0.6 up to 1.0 millimetres.

Both coupling surfaces are level faced, so that the user can control it from any desired axial and radial positions for coupling. Finally the stroke guides an internal moving piston out by the control pressure **A**. It is possible to control individual couplings specifically. The control pressure **A** is to be supplied with the same pressure as the media pressure **P**. When the control port **A** is not pressurized, the AKM is set into the basic position. The AKM can be operated single-acting or double-acting. If the AKM should operate single-acting, the port **B** must be used for housing ventilation.



Automatic coupling mechanism and coupling nipple, coupled without pressure, nominal diameter 5, screw-in system

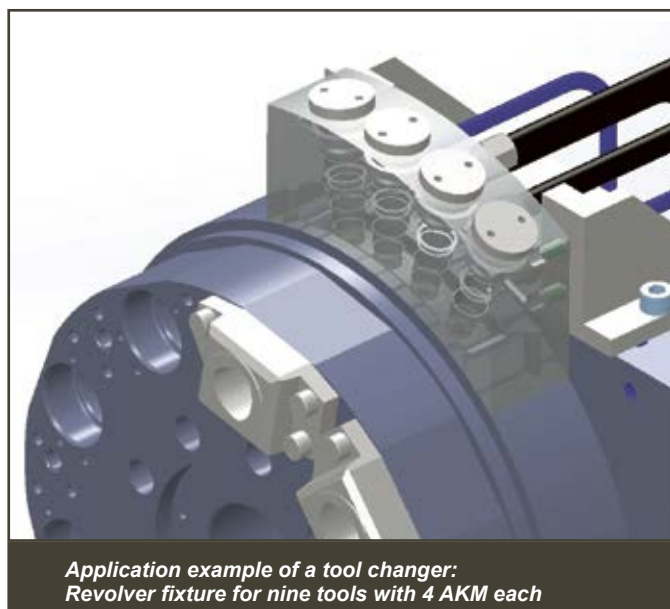

Application example of a tool changer: Revolver fixture for nine tools with 4 AKM each

Tool clamping fixture increases productivity continually

The industrial users confirm useful value of the AKM far above other couplings. Heckert, for example, uses a hydraulic double-acting AKM in a special support of the HED large machining centre 1000 to 1800. It couples the tool axis in standstill, to apply hydraulic fluid on it or the tool. This means that the gap of approx. 1mm safely allows the rotation even during machining.

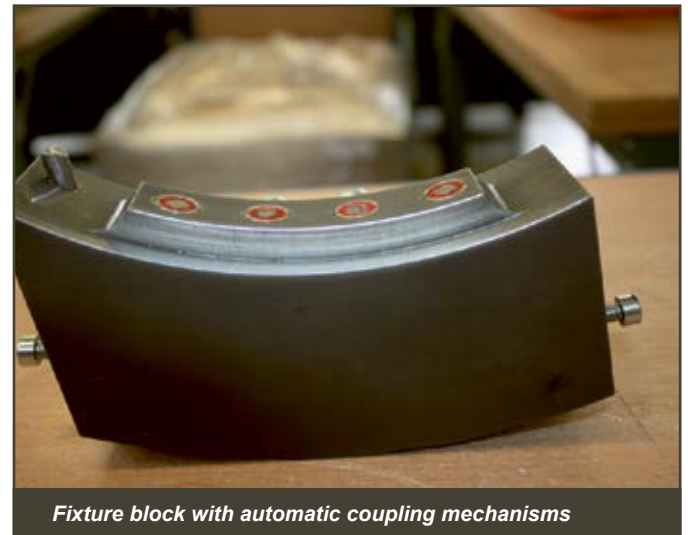

Fixture block with automatic coupling mechanisms

Before use of the AKM the experts in Chemnitz laboriously generated the coupling function using an additional moved axis with a stroke of 5 mm. Alternatively they had thought about a multi-channel rotating bush. However, the realisation of this idea was somewhat problematic, firstly, due to the high rotational speed and secondly because the required installation space was not available. Support with the AKM functions reliably according to their test since 2014.



The revolver with a total of 36 coupling nipples

Additional information:

Subject	Data sheet	Webcode
☒ Coupling elements	100-3	010003
☒ Automatic coupling mechanisms	100-6	010006



Tool clamping fixture increases productivity continually

For machining body elements a tool machine manufacturer had the concept of a rotary indexing machining centre (BAF).

The well-known Tier 1 automotive supplier used it to machine 4500 right and left mirror-image elements per shift. In addition to the drilling and milling machining that determined the main time, the clamping fixtures from HYDROKOMP contributed a significant portion to achieving the high productivity.

The BAZ consists of one loading, four working and one unloading stations. An identical change fixture is installed in each of the six stations. It picks up the workpiece and implements the basic functions: positioning, clamping and supporting. Each of the four hydraulic clamping components must securely fix the workpiece during the machining in the four stations, in the loading and loading stations on the other hand, release for change or reclamp.

The cycle time is only 8 seconds. This requires in the 3-shift operation maximum availability of all participating components and a high degree of professionalism and reliability from the manufacturers. For this reason HYDROKOMP developed a combined hydraulic-pneumatic rotating bush. The controlled hydraulics functions according to the rotary slide principle. It supplies the four machining stations with the continuous pressure required during the main time for secure clamping.

The designers selected swing clamping elements due to the accessibility to the clamping area. To compensate for the workpiece tolerances, their custom clamp arms are partially equipped with pendulum thrust pieces.

For the loading and unloading stations valves control the opening and closing of the oil supply for the clamping elements in synchronised time. The rotating bush contains a six more uncontrolled cycles for the pneumatics. It monitors the placing of the workpieces in the 6 stations according to the dynamic pressure principle.



Rotary indexing machining centres with change fixtures for efficient clamping of the body elements in the six stations



The base body of the change fixture contains hydraulic coupling for automatic opening and closing of the hydraulic supply during the loading and unloading processes

In every shift the rotary indexing BAZ produces both different automotive parts. Thus the worker changes the complete six fixtures in the stations.

The fast and safe changeover of the hydraulics and with it the fixture change support HYDROKOMP couplings. They open and close automatically during the fixture change. Couplings with 12 l/min flow rate (nominal width 5) are sufficient, laid out according to the clamping elements.

Additional information:

Subject	Data sheet	Webcode
⊗ Coupling elements	100-3	010003
⊗ Multiple coupling systems	100-4	010004
⊗ Mounting tools	100-5	010005
⊗ Rotary couplings	500-3	050003



Pressure oil transfer at tool changers on robots

In complex assembly-, automatic assembling- or production processes tool changers allow the exchange of follow-on tools.

Depending on the corresponding force density to the tool either pneumatics or hydraulics are applied. For both media it is economical, for hydraulics it is absolutely essential, that the coupling elements operate leakage-free in coupled or uncoupled state.

The constructive design of the HYDROKOMP elements guarantees these fundamental valve functions. The special axial sealing function of the coupling elements provides full flow at a stroke of only 4.5 mm. This construction shows, that the coupling elements are very compact and can easily be integrated into existing constructions.

Another advantage of the axial system sealing is that between both coupling components a radial positioning tolerance of +/- 0.2 mm is allowed.

The photos show tool change modules where two hydraulic lines are coupled through screw-in couplings (M24x1.5) by HYDROKOMP.

Coupling connection blocks for robot-changing fixture

Components: coupling elements, nominal diameter 8, Operating pressure max. 250 bar, Qmax 25 l/min.

Volume supplied by HYDROKOMP were the complete connection housings from aluminium with mounted and tested coupling elements.

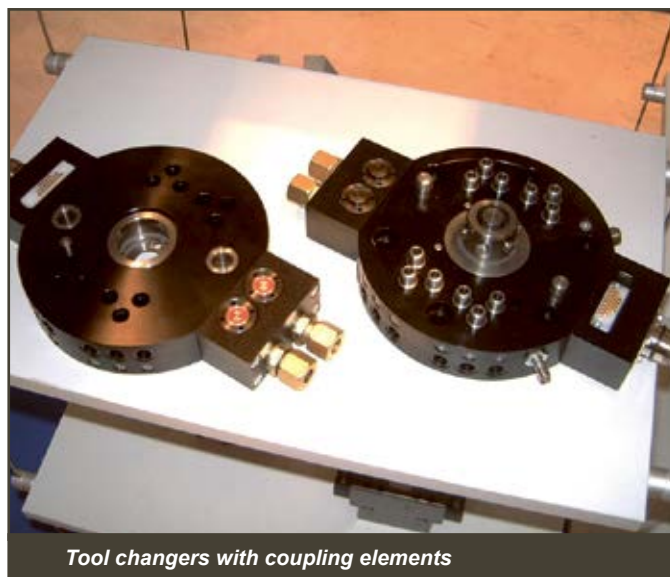

Tool changers with coupling elements

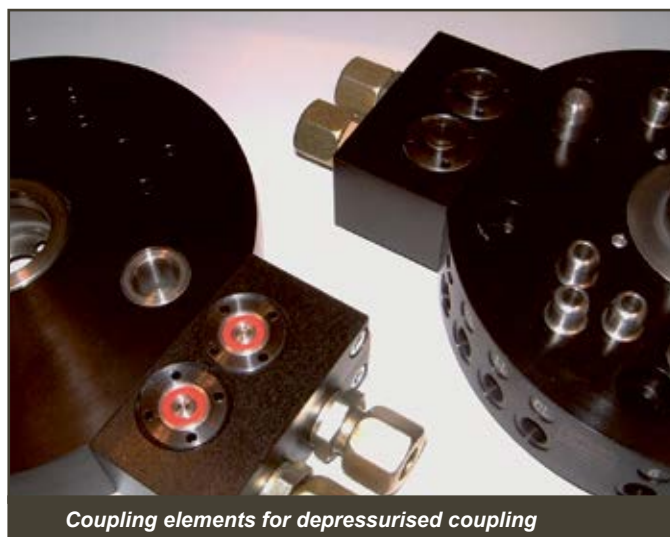

Coupling elements for depressurised coupling

Interface for changing devices at a flanging fixture

Coupling elements as a pressure oil interface for a robot's changing tool. In total the system consists of three changing tools which are used for non-cutting moulding in the car spare parts production.

The hydraulic pressure is 250 bar max. and in every action a tool is pulsed approx. 300 times to max. operating pressure. Per shift (2-shift-operation) the tools are changed approx. 60 times.

Since the workpieces are painted after being machined, the user put a main emphasis on a low leakage rate.

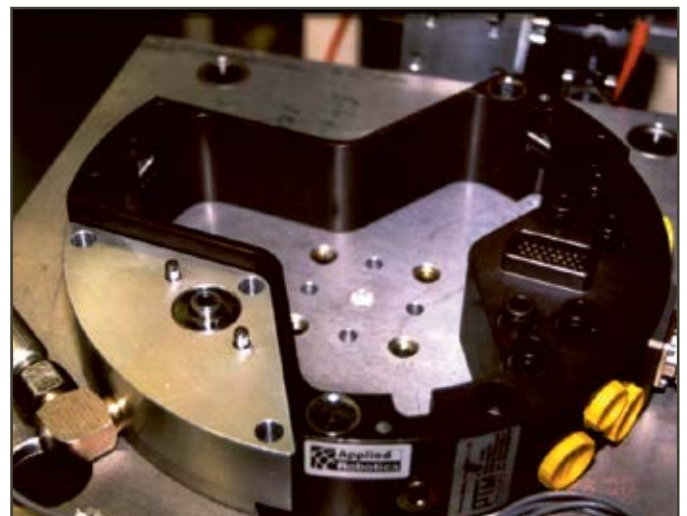

Additional information:

Subject	Data sheet	Webcode
☒ Coupling elements	100-3	010003
☒ Mounting tools	100-5	010005



Hydraulic interface to support the efficiency of fabrication

Our customer Honsberg-Lamb GmbH uses coupling technique by HYDROKOMP for the pressure oil supply of their fixture pallets. In the loading and unloading station the connection to the threefold-coupling is achieved by lowering the pallet.

The guided movement happens in the admitted tolerance area of the coupling of $\pm 0,2$ mm.

The cleaning by a spring-weighed blast pipe is supported by the plain surface of the coupling elements. The long life of the coupling elements supports the high availability of the machine.

If necessary, advised operating personal can change the seal elements locally and quickly.

Assembled coupling elements:

- Coupling mechanism plate KMP-460-5-K013
- Coupling nipple plate KNP-460-5-K013k

HYDROKOMP has developed a suitable mounting tool to change the seals of the coupling mechanisms simply and safely.



Coupling elements in plastics-injection moulding tools

An application in a two-component-plastics-injection moulding tool. To mould a workpiece from two plastics components the front tool plate is reversed by 180° between both moulding procedures. In the shown construction hydraulic hoses were used for oil supply of the hydraulic core pull. At the swinging process these have been destroyed many times and leaking hydraulic oil has caused great damage.

With the solution concept by HYDROKOMP the coupling elements disconnect and connect the oil supply at every swinging process in this application in pressureless state. Besides the improved production process also safe operation and the reject rate have been substantially improved.

Assembled coupling elements:

- Coupling mechanisms KM-460-5-EG001
- Coupling nipples KN-460-5-S001k

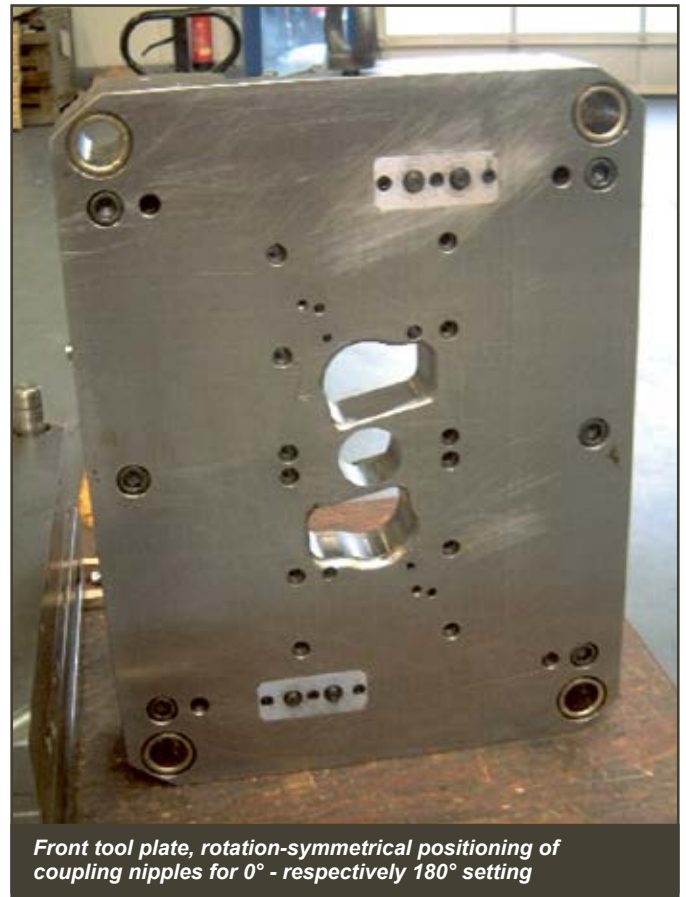

Additional information:

Subject	Data sheet	Webcode
☒ Coupling elements	100-3	010003
☒ Multiple coupling systems	100-4	010004
☒ Mounting tools	100-5	010005



Two-fold coupling plate in the loading and unloading station of a machine tool

For pressure oil transfer in the loading and unloading station the fixture plate will be supplied over two coupling elements with pressure oil.

With this coupling plate, a pressure and a tank line can be connected together. Standardized coupling elements with three, four, five, seven and eighth lines are available.

The cleaning by a blast pipe is supported by the plain surface of the coupling elements. For optimal improvement on the surface, e.g. it is possible to close the counter-bores with plastic plugs. As counter-elements, it is possible to use coupling nipples with different designs. Beside the complete nipple plates you can use the threaded-body or build-in elements.

HYDROKOMP coupling mechanisms are designed in such a way that the front system seal can be replaced. This seal is subject to wear out in everyday use as a result of contamination and metal filings.

If the coupling mechanism itself shows no damage, the system seal can be replaced on its own. This can be accomplished by the user or by external service personnel.

HYDROKOMP has developed a suitable installation tool to accomplish this seal replacement simply and safely.

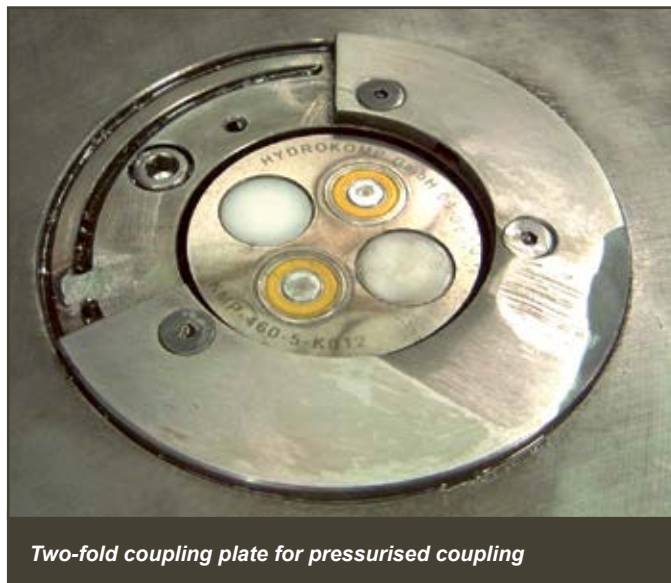

Two-fold coupling plate for pressurised coupling

Docking station with six coupling points

for pressurised coupling; in order to dock the coupling plate, it is raised by an integrated hydraulic cylinder. An electronic sensor queries the position. The positioning of the counter-couplings is realized by two bolts.



Coupling plate for transmission of hydraulic oil

in the loading and unloading station of a fixture plate. The six coupling elements are coupled pressurised.

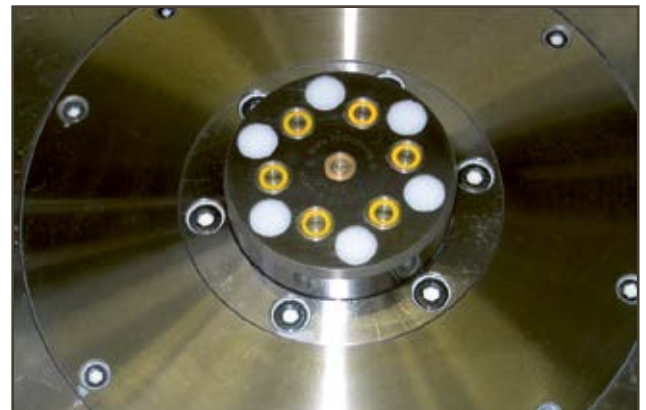

Tool-change system for a handling unit in a robot

with four coupling elements (nominal diameter 8) as interface for a hydraulically operated cutting tool



Additional information:

Subject	Data sheet	Webcode
⊗ Coupling elements	100-3	010003
⊗ Multiple coupling systems	100-4	010004
⊗ Mounting tools	100-5	010005



Docking system in machine tool BlueStar®

Coupling system with hydro-mechanical locking in the loading and unloading station. In such projects it is crucial for an innovative solution that the partner enterprises are included at an early stage in the brainstorming process relating to the design concepts.

The result for the BlueStar5® is a coupling design that accommodates the fitting of two, four, six or eight media connections in the loading and unloading station.

Bearing in mind the objective that the machine is to be marketed as a cost-effective option, HYDROKOMP was also obliged to take this aspect into account.

HYDROKOMP's approach to this solution consisted of offering a docking system in which the jig pallets in the loading and unloading station are not clamped by means of the clamping cones in order to absorb the coupling forces that arise. This function is undertaken by the docking system itself.

In all the designs a separable connection is achieved between the lower, stationary and the upper, mobile halves of the coupling by means of hydro-mechanical locking pins.

In the machining station this locking function is once more taken over by means of the clamping cones. Here a coupling plate is fitted with two connections, connecting the pressure lines of the hydraulic clamping jig during machining, thus enabling pressure monitoring.



Coupling plates of the docking system

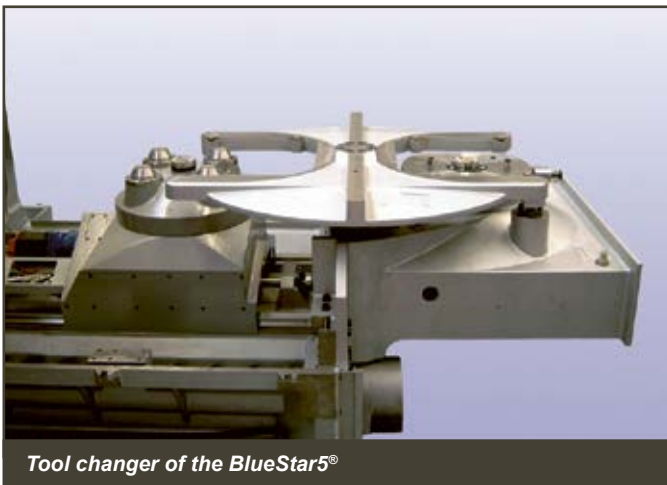

Tool changer of the BlueStar5®

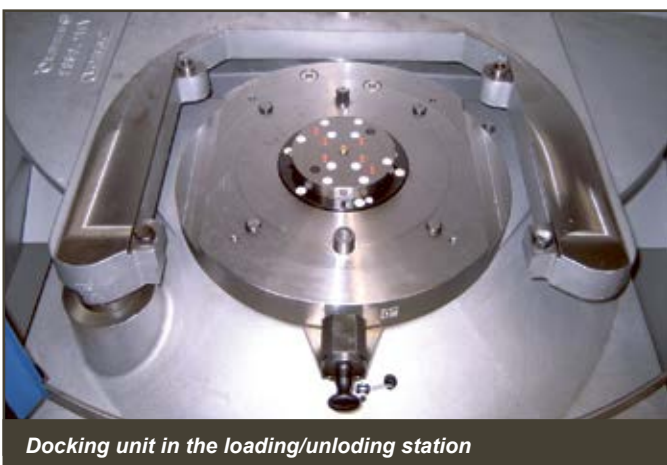

Docking unit in the loading/unloading station

The docking unit in the loading and unloading unit is equipped with a rotary coupling, which permits rotation of the hydraulic clamping jig through 360°.

The media connections within the sub-assembly are effected by means of drilled channels. Installation of the coupling sub-assemblies is always carried out directly, making them easy to install and service.

The illustrations show that the configuration principle of the docking systems is designed to meet the particular requirements of a machine tool. In addition to their compact design, other points worth mentioning are the ease with which they can be kept clean and maintained.

The smooth surfaces and the centre, spring-mounted air-jet help to maintain cleanliness. It can be demonstrated that the level of contamination of the couplings has a direct effect on their service life.

For that reason it is important to exploit all the design options when configuring machines and jigs, in order to reduce contamination of the docking systems.

In the area of maintenance, HYDROKOMP supplies an installation tool with which the frontal system seals can be very rapidly replaced without dismantling the coupling elements.

With its unequalled expertise in this area, HYDROKOMP is setting future trends with this family of docking systems. We will be happy to demonstrate to you that our strengths include not only our engineering solutions but also quality and delivery reliability.

Additional information:

Subject	Data sheet	Webcode
☒ Coupling elements	100-3	010003
☒ Multiple coupling systems	100-4	010004
☒ Mounting tools	100-5	010005
☒ Rotary couplings	500-3	050003



Innovative docking system for pallets and other change systems

We call our innovative docking system simply KDS for coupling rotation system (German abbreviation). Our designers solved the task of now clamping pallets in the loading and unloading station with the rotating bush expanded to the coupling instead of clamping tapers supplied hydraulically.

The docking system created in this manner enables tool machine manufacturers and other machine builders to realise more economical change system with the same degree of clamping safety, for example for workpiece pallets.

Customers such as DMG, Heckert, Heller, MAG and Makino spoke to us about saving-possibilities with the pallet change systems. The starting point is our experience and solutions with hydraulic couplings. The result is the innovative docking system. It establishes a detachable connection with hydraulically actuated locking pins in the locking and unloading station. They connect coupling half fixed below in the station mechanically with the one fastened on the pallet and with its movable upper coupling half. During setup and removing the workpieces the pallet can be rotated 360°.

The clamping tapers common up to now including their hydraulic supply are now completely gone in the loading and unloading station. This results in a significant cost reduction. It has several times the amount of the additional cost of the KDS in comparison to the normal rotating bush. This coupling principle is suitable for changing tools, grippers or also other components on machines, e.g. punching robots.



4-fold coupling system with hydraulic clamping, coupling nipple plate with glow jet, combined with 6-lead rotating bush NW5, can be coupled without pressure (left) coupling mechanics plate



2-fold coupling system with hydraulic clamping, flow jet and 4-lead rotating bush, coupled without pressure



7-fold coupling system with hydraulic clamping, flow jet and 7-lead rotating bush, coupled without pressure

Because the coupling half in the loading and unloading station during the clamping operation can contaminate, a specially formed blow jet is integrated. It is arranged in the centre and connected to the compressed air supply. To guarantee universal use, the developmental elements are made of rust resistant stainless steel. That means, they can also carry aggressive coolant and gases. Up to 16 applications are normal.

The standard design for the KDS is for pallets up to 1600 x 1600 mm. The system pressure can be up to 200 bar. The coupling rotation systems can be selected for 8 to 50 l/min depending on the application conditions. Depending on the design the diameters of the KDS are 40 to 200 mm. Due to the competency and flexibility in the design and production, HYDROKOMP meets customer demands for custom solutions, usually on short notice.

Additional information:

Subject	Data sheet	Webcode
☒ Coupling elements	100-3	010003
☒ Multiple coupling systems	100-4	010004
☒ Rotary couplings	500-3	050003



Multifunctional rotating bush transfers fluid media and control signals

HYDROKOMP is forming a space saving and labour saving path. Independent of the number of clamping stations, the multi-functional rotary coupling MFD transfers the pressure and return of a fluid medium via only two channels.

In addition it delivers electronic control signals to the fixture. More media lines, e.g. for air or water, are optionally available for the user.

Hydraulically driven fixtures on rotary tables are normally activated directly over the rotary couplings. In addition every clamping station requires one or more hydraulic lines. The length and installation space of the rotary couplings are increased corresponding on the number of clamping stations.



Electrical slip ring transmitter instead of many fluid lines

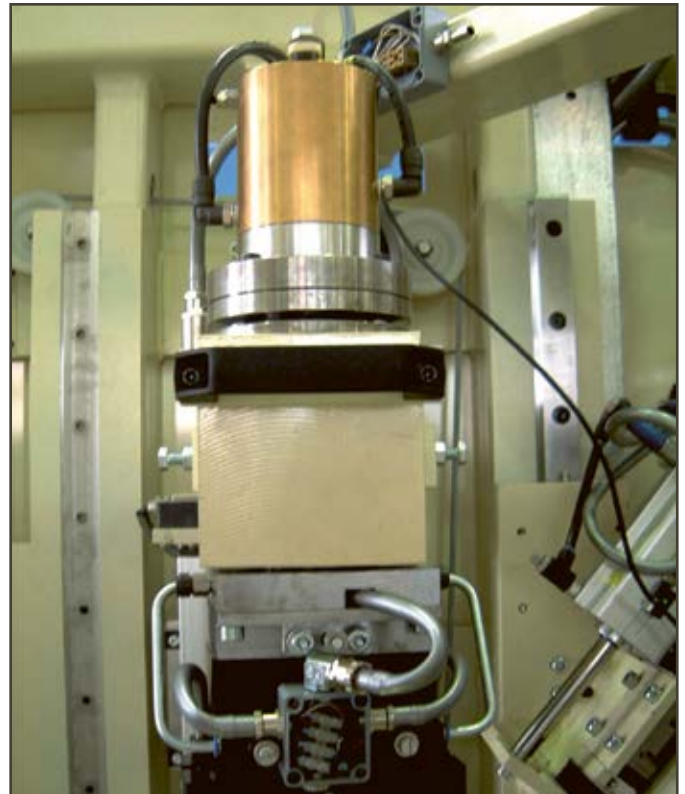

With the HYDROKOMP solution an electrical slip ring transmitter replaces to a large extent the fluid lines. The work table or the fixture accepts the valve block for the clamping equipment. Instead of 6 to 24 lines, with the MFD only two lines supply all valve blocks. To control the valve blocks or the clamping stations, the slip ring transmits the electronic control signals. Their amperage can be up to 2 A and voltages up to 24 V. In this way the user saves installation space and line and leak labour. On customer request the rotary couplings can also be produced for Profibus and other applications.

HYDROKOMP produces mainly MFD rotary couplings with nominal diameters between 40 mm and 200 mm. The hydraulic pressure can be up to 500 bar and the gas or air pressure 10 bar.

The rotary couplings are manufactured out of corrosion protective materials such as brass or corresponding steels.

Typical applications are welding of lorry and construction machine parts, mechanical processing of large components in rotary indexing machines or surface treatment and cleaning in several work stations. The small installation length of the rotary coupling MFD makes it easier to convey application-specific other media, e.g. purging gas during welding or coolant lubrication during the machining process.

Other application examples for MFD



Rotary coupling, 3-lead, compressed air, hydraulic oil and Profibus 24 VDC.



Rotary coupling, 1-lead, compressed air

Additional information:

Subject	Data sheet	Webcode
⊗ Rotary couplings	500-3	050003
⊗ Rotary valve couplings	500-4	050004



Rotary valve coupling for hydraulics, pneumatics, water and electrical energy

The rotary coupling shown below transmits two cores hydraulics with max. 240 bar, four cores pneumatics (10 bar) and has an electrical rotary connection which transmits 6 times 24 V with 2 A.

The electrical rotary connector controls hydraulic distribution valves through which several clamping elements clamp the workpiece hydraulically.

The max. rotational speed of the version is determined by the hydraulic pressure, the diameter of the sealing and the number of stressed sealings. The value of the friction force resulting from these parameters is the limiting factor. In the mentioned case the max. rotational speed is 25 1/min.

The photo below shows the electrical rotary connection mounted into the lid. To the side and the front the cables are made moistureproof through cable fittings. Through a double sealing package a leakage connection is provided between the individual media.



6 fold rotary coupling for hydraulic oil and electrical energy

12 and 6 passage rotary coupling, nominal diameter 5

provide two fixtures with pressurized oil. The 180° pallet changer swifels both fixtures between the loading-/unloading station and the work station.

Both six passage rotary couplings rotate 360°. The twelve passage rotary coupling was designed with special seal elements to produce an insignificant torque.

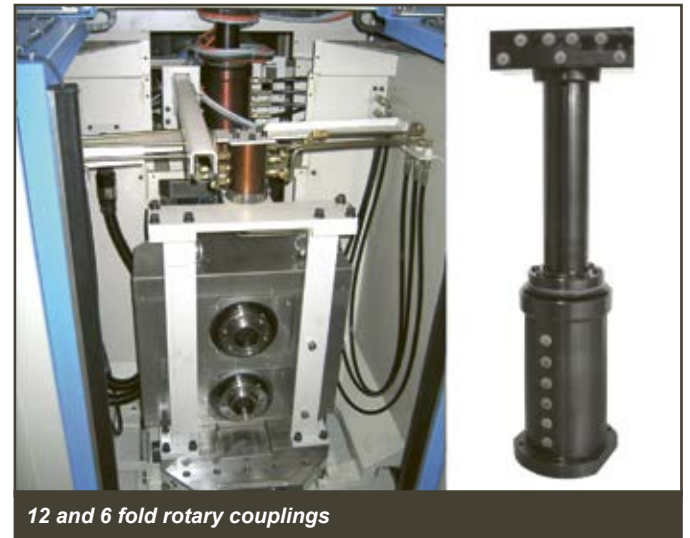

12 and 6 fold rotary couplings

Twin passage rotary coupling

mounted in an articulated bracket construction on a 2-pallet tool machine. One rotary coupling each is mounted in the rotating axis of the two fixture pallets and allows the rotation of 360°.

The pressure supply in the rotating axis of the 180° pallet changer is done by hoses. Utilised operating pressure = 240 bar, nominal diameter 5

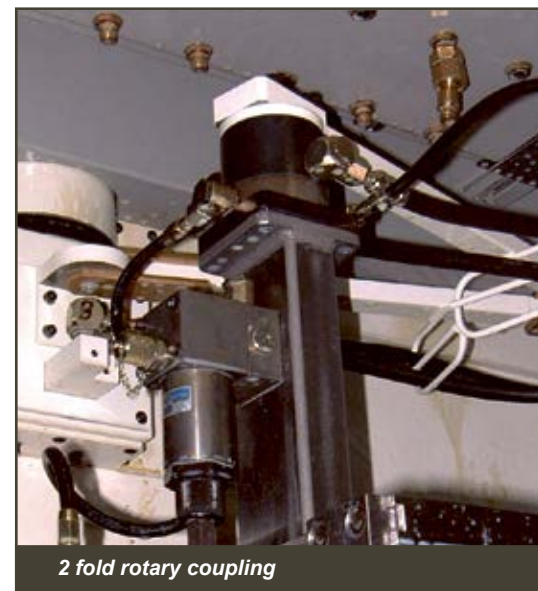

2 fold rotary coupling

Additional information:

Subject	Data sheet	Webcode
⊗ Rotary couplings	500-3	050003
⊗ Rotary valve couplings	500-4	050004
⊗ Pneumatic rotary coupling	800-1	080001





Steady bearing with integrated rotary valve coupling

Besides the possibility to make multiside machining also multiple clampings can be realized (depending on the workpiece). For that, due to clamping quality and effectiveness hydraulic elements should be applied.

For oil supply HYDROKOMP has developed a steady bearing which combines bearing, bearing clamping and rotary valve. Above that the rotary valve is equipped with a control function which allows clamping and releasing only in a defined position.

Another advantage is the characteristic that the bearing clamping can be supplied with the same hydraulic pressure as the clamping elements. That way it is not required to reduce pressure at the hydraulic aggregate.

With this construction the space requirement for the clamping device can be maximized, the one for the steady bearing can be minimized and the costs for hydraulic and electrical controls can be optimized.

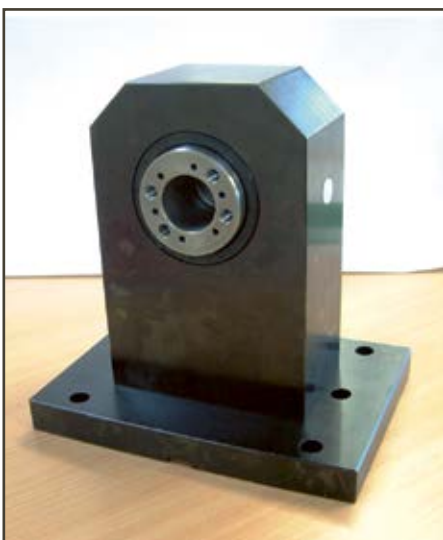

Rotary valve coupling in a support bearing of a reversible clamping device

The design of the rotary valve coupling only permits loading and unloading when the device is turned to a predefined position.

This means that it is impossible for the item to become unclamped in the machining positions. Installation in the thrust bearing is extremely compact, saving valuable machining space for the clamping of workpieces.

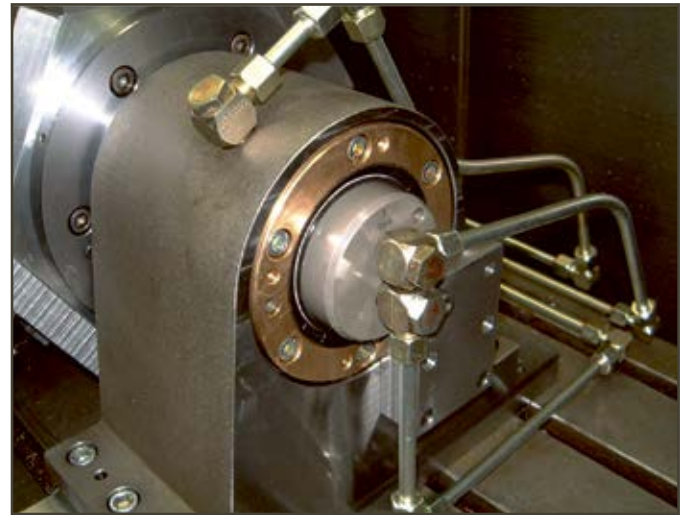

13 passage rotary coupling

with 6 connections for compressed air, 6 connections for cooling water, 1 connection for forming gas, electronic slip rings 12 x 24V, 2A per line.

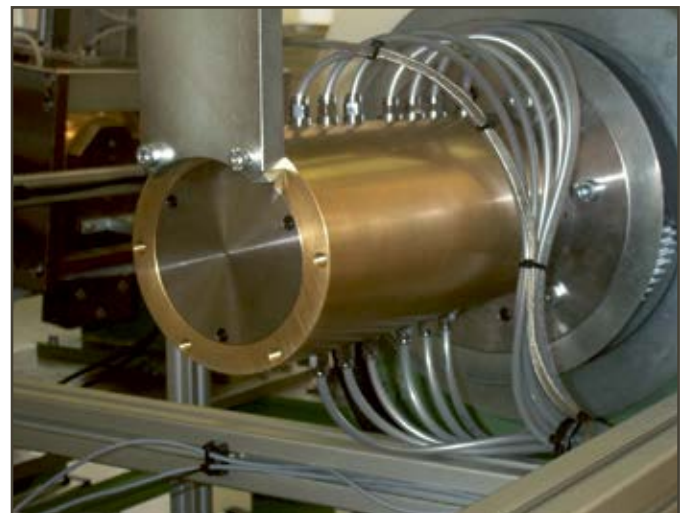

Additional information:

Subject	Data sheet	Webcode
⊗ Rotary couplings	500-3	050003
⊗ Rotary valve couplings	500-4	050004
⊗ Pneumatic rotary couplings	800-1	080001



Universal, practical, flexible and secure clamping

Complete programme of hydraulic swing clamp cylinders (SSZY)

For fast, precise and secure clamping and releasing of workpieces, HYDROKOMP offers an application-oriented hydraulic swing clamp cylinder program. It covers both the standardised and the customer-specific solutions. Thus the user can select single- or double-acting pull cylinders, various swing angles between 0 and 90° right or left, standard or special clamp arms or his own fabrication.

A special feature of the swing clamp cylinders are the standard integrated metal wipers. They increase the service life of the cylinder significantly.

With up to 500 bar operating pressure the cylinders generate effective clamping forces of maximum 40 kN. An integrated overload protection protects the swing mechanics from damage, if during the swing process a block occurs or the clamp arm is not mounted correctly.

In double-acting cylinders the hydraulic moves the cylinder both to clamp and to release. The function of releasing is done by a pressure spring for the single-acting cylinder. For fixing the clamp arms there are three designs available:

- Clevis with pin and safety rings
- Tapered fixture with fastening nut
- Pendulum eye

The user selects the type of housing according to the fixture. With six variants for each size, HYDROKOMP offers the correct solution for conventional installation and for the working situations. Swing clamp cylinders according to customer request are also designed and produced.

The pressure oil is supplied by pipe threads, flange with O-ring or drilled channels.

The piston diameters are 25, 32, 40 or 63 mm and the clamping stroke 10, 13 or 14 mm.

For all sizes the minimum actuating pressure is 30 bar, the maximum volume flows vary from 3.2 over 10 to 27.7 cm³/s.



Additional information:			
Subject	Data sheet	Webcode	
☒ SSZY, Selection guide	-	-	
☒ SSZY, Safety Instructions	-	-	
☒ SSZY, Clamping arms	240-0	024000	
☒ SSZY, lower flange	240-2	024002	
☒ SSZY, threaded body housing	240-3	024003	
☒ SSZY, upper flange	240-10	024010	
☒ SSZY, upper flange	240-20	024020	
☒ SSZY, lower flange/thread	240-30	024030	
☒ SSZY, Block housing	240-40	024040	
☒ SSZY, threaded body housing	240-50	024050	



Hydraulic multiple rotary clamping fixture

Cost pressure, time pressure, flexibility, quality standards, reduction in non-productive time, set-up time, all catchwords with which a production company is confronted in everyday operations and terms that formulate objectives. In this case a high number of items were to be machined annually, in production batches of 60 in one clamping.

The most useful clamping solution was a multiple rotary clamping fixture, which permits both multilateral machining of the workpieces and multiple clamping. This solution was substantially determined by the use of the existing machine tools with a vertical spindle.

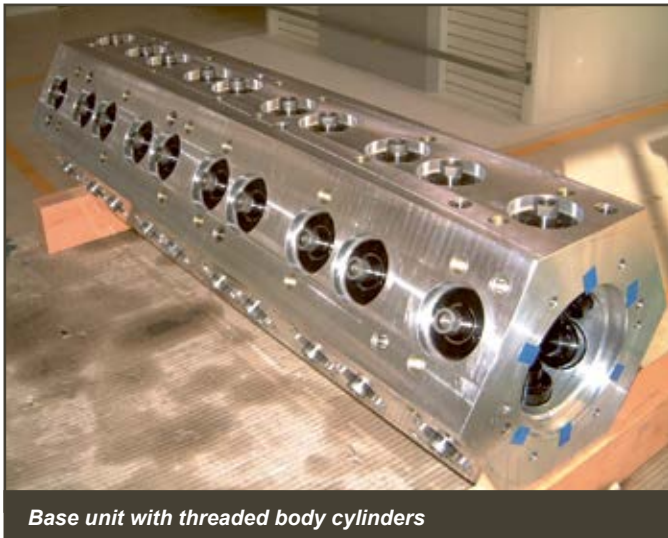

Base unit with threaded body cylinders

HYDROKOMP was commissioned as a manufacturer of hydraulic clamping elements to design this device. For this purpose a clamping concept was developed in advance, together with production planning.

A rotary valve coupling is installed in the counter bearing, so that only the upwardly facing side of the fixture can ever be clamped or unclamped.

Advantages of many types are offered by this design principle. Using normal rotary couplings, it would be necessary to employ a six-way rotary coupling. This requires more space and generates more kinetic torque as a result of the necessary seals.

There are additional costs because each connection plane must be fed by means of a hydraulic distribution valve including electrical control unit. This makes it possible to provide five sides of the fixture with constant pressure and to clamp and unclamp hydraulically only the sixth side facing upwards.

The individual clamping nests are designed in such a way that a total of three different workpieces of a parts family can be clamped. It is merely necessary to turn the lateral stop through 180°. All other positioning and clamping points remain in place.

The bar fitted between the two clamps is to prevent the clamps from twisting. For the optimum transfer of clamping force there are hardened balls fitted in the clamping tips of the clamps, which press into the workpieces and thus create a positive fit.

The lower support points are level. The threaded body cylinders are designed as single-acting pull cylinders with spring reset and are built into the base unit.

All HYDROKOMP cylinders have two wiper elements on the connecting rod side. In addition to the soft wiper ring there is a metal wiper ring fitted, which wipes off even the smallest pieces of swarf. The supply of hydraulic oil takes place inside the fixture, via drilled oil channels only. As the overall length is 880 mm, oil channels 5 mm in diameter have been inserted from both sides. The aim of this design variation is for the entire device to be universally applicable by exchanging the top, workpiece-specific fixture plate.

There is a small pump unit acting as a pressure generator, with two single-acting clamping circuits, with one of the clamping circuits being equipped with a pressure reducing stage, which limits the operating pressure for clamping the counter bearing to 60 bar.

The control units of the machine tool, of the NC divider and of the hydraulic unit are thus linked together in such a way that mutual enquiries take place before the next step of the programme takes place. In this way all the safety regulations that are necessary for sustained and responsible operation are met.

To sum up, it can be said that hydraulic rotary clamping fixtures offer tremendous economic benefits for the machining of workelements in mass production. The hydraulic clamping elements guarantee consistent and secure clamping. Some advantages:

- Multilateral machining of the workpieces
- Reduced tool-changeover times
- Reduced workpiece-changeover times
- High clamping security and clamping quality
- Increased machine running time

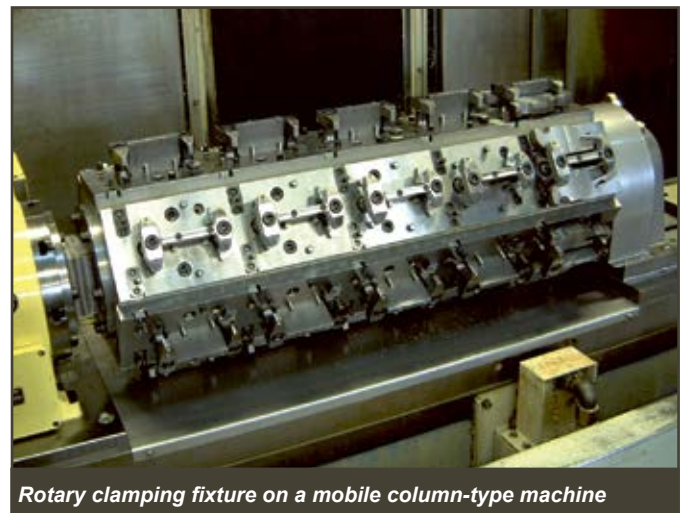

Rotary clamping fixture on a mobile column-type machine

Additional information:

Subject	Data sheet	Webcode
⊗ Threaded body cylinders	200-2	020002

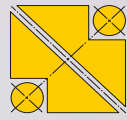

HYDROKOMP®

Hydraulische Komponenten GmbH

Technology that connects



Customized solutions for maximum productivity

**For customized modifications and special designs
we will be pleased to support you.**

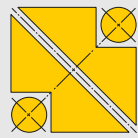

HYDROKOMP
Hydraulische Komponenten GmbH

Advice, customer service and technical support



For further detailed information in reference to our **products, services and special designs, for advice and in case of technical questions**, our application engineers and development engineers will be pleased to support you.

Get in touch with us!

Monday - Friday
07:00 - 16:00



+49 6401 225999-0



info@hydrokomp.de



Siemenstr. 16
35325 Mücke (Germany)



www.hydrokomp.de

HYDROKOMP Product configurator!

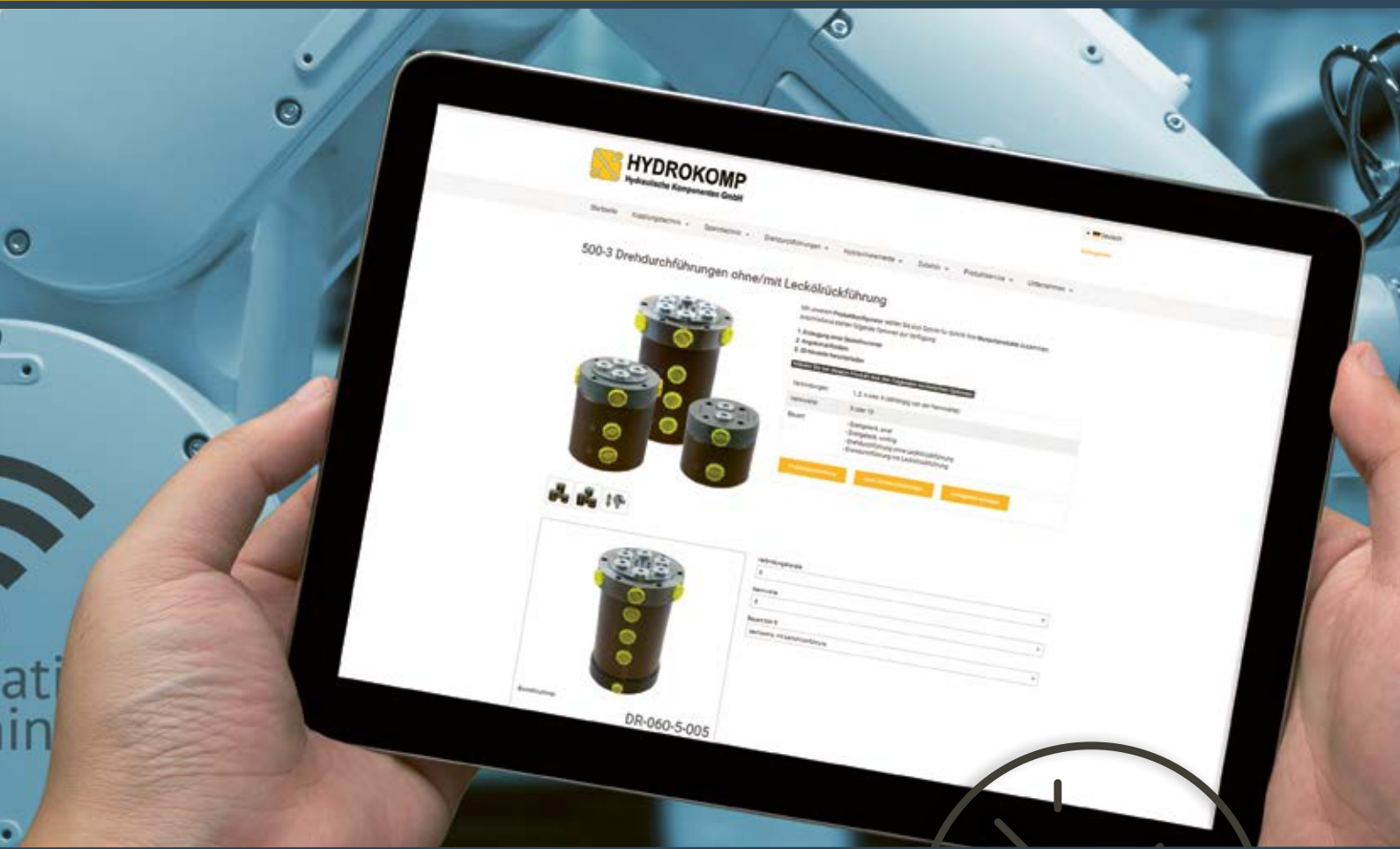

Customize your
HYDROKOMP product
by yourself online!



With just a few mouse clicks to the perfect individual solution:

Our web-based **Product configurator** allows you to choose many product variations and adapt it to your specific needs. Our extensive **Product customization** enables you to find the perfect individual solution for your project.



Select HYDROKOMP products at www.hydrokomp.de



Call up the HYDROKOMP Product configurator and customize products individually.



Get order number, send inquiry and download 3D models. Price and delivery dates will be sent to you.

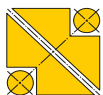

HYDROKOMP®
Hydraulische Komponenten GmbH
Technology that connects

For customized modifications and special designs we will be pleased to support you.

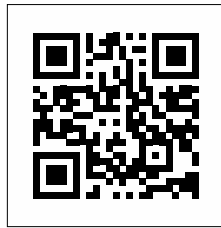

More than 1,000 products are available at www.hydrokomp.de

For customized modifications and special designs we will be pleased to support you.



HYDROKOMP
Hydraulische Komponenten GmbH



+49 6401 225999-0
+49 6401 225999-50



info@hydrokomp.de



Siemensstraße 16
35325 Mücke
(Germany)

